



# Shoe Store Assembly Instruction ----- Drawers

## Content:

A. Front Panels	2 pcs	F. Small shelves	2 pcs
B. Side Panels	4 pcs	G. $\Phi 3.5 \times 25$ Screws 	48 pcs
C. Back Panels	2 pcs	H. $\Phi 3 \times 14$ Screws 	20 pcs
D. Bottom Panel	2 pcs	I. Handles & $\Phi 4 \times 20$ mm Bolts 	4 sets
E. Large shelves	4 pcs		

## Assembly instruction (as shown in figure 1 to 3)

Before assembly, please put all contents on a soft surface. Numbered stickers are attached as a guide on parts and should correspond when assembling the unit

1. Attach side panels (B) to front panel (A), using the long screws (G) as shown in figure 1.

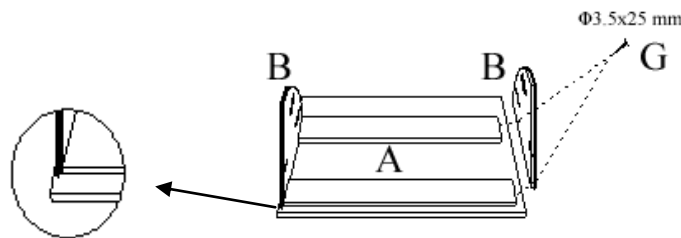

**Fig. 1**

2. Insert shelves (E & F) to slots of side panels (B) and fix them together using long screws (G), then attach back panel (C) to side panels (B) using long screws (G) Then attach bottom panel (D) to the drawer using short screws (H) as shown in figure 2.

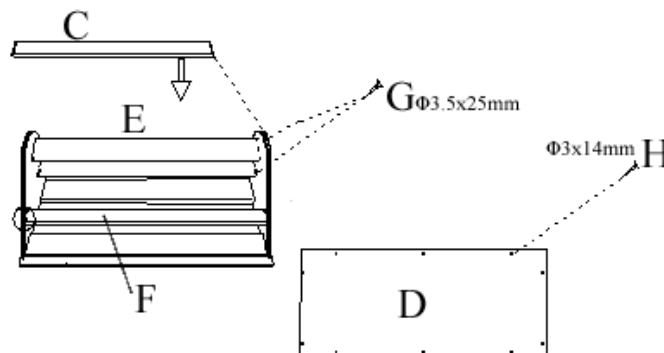

**Fig. 2**

3. Attach handle (I) to the drawer as shown in figure 3.

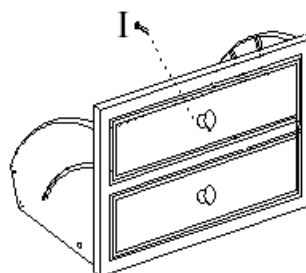

**Fig. 3**

## D763 Shoe Store Assembly Instruction ----- Cabinet

### Content:

J. Top panel	1 pc	N. Wooden plugs $\Phi 8 \times 30 \text{mm}$	4 pcs
K. Side Panels	2 pcs	O. Bolts $\Phi 6 \times 35 \text{mm}$	8 pcs
L. Bottom Panel	1 pc	P. Allen Key	1 pc
M. Back panel	1 pc	H. $\Phi 3 \times 14$ Screws	14 pcs

### Assembly instruction (as shown in figure 4 to 5)

Before assembly, please put all contents on a soft surface.

1. Attach 2 drawers to side panels (K), make sure that wooden pins on cabinet's side panels are inserted into bow slots and holes in drawers' side panels, the numbers on the drawers must match the numbers on the cabinet's side panels..
2. Attach top panel (J) to side panels using bolts (O), and tighten with Allen key (P).
3. Insert wooden plugs (N) into holes of side panels, then attached bottom panel (L) to side panels using bolts (O), and tighten with Allen key (P).
4. Attach back panel (M) to the cabinet using smaller screws (H).

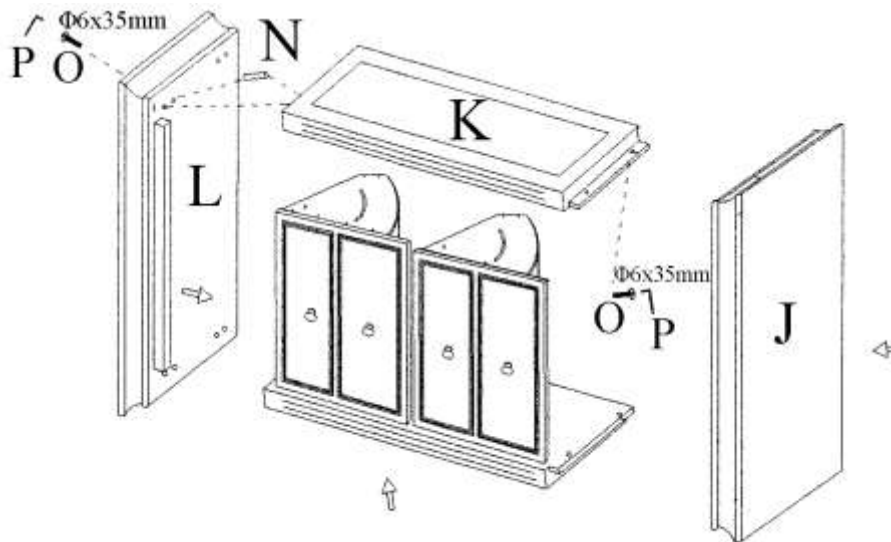

**Fig. 4**

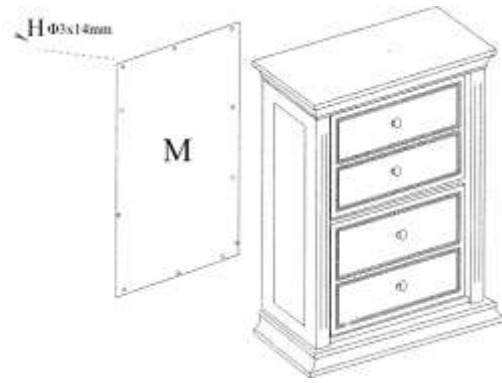

**Fig. 5**

*Note - please ensure that the Shoe Store is located on a level surface and to minimize risk of tipping forward please only open one drawer at a time*